

# ELEMENTO LINEARE - STRAIGHT ELEMENT - LONGUEUR DROITE

Articoli imballati singolarmente / One item boxes / Articles emballés séparément

Lunghezza / Length / Longueur: 1000 mm

Cod. / Code / Réf.	Ø Interno / Internal / Intérieur	Ø Esterno / External / Extérieur
10DPG80X1000	*80	100
10DPG100X1000	*100	120
10DPG120X1000	*120	140
10DPG130X1000	*130	150

Lunghezza / Length / Longueur: 500 mm

10DPG80X500	*80	100
10DPG100X500	*100	120
10DPG120X500	*120	140
10DPG130X500	*130	150

Lunghezza / Length / Longueur: 250 mm

10DPG80X250	*80	100
10DPG100X250	*100	120
10DPG120X250	*120	140
10DPG130X250	*130	150

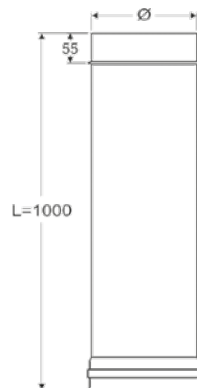

**Diametri differenti su richiesta** - Custom diameters upon request - Diamètres différents sur demande

**\* Guarnizione e fascetta stringitubo incluse** / gasket and clamp included / joint d'étanchéité et collier de jonction compris

## CURVA 90° - 90° ELBOW - COUDE À 90°

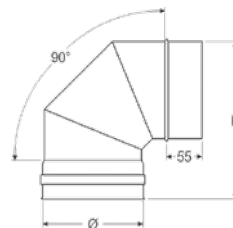
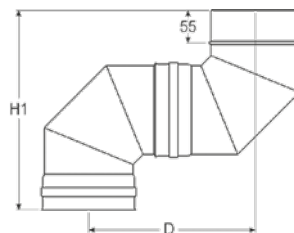

Cod. / Code / Réf.	H	H1	D	N° SET	Ø Int. / Inte. / Intér.	Ø Est. / Exte. / Extér.
10DPGC80/90	228	356	301	3	*80	100
10DPGC100/90	248	376	321	3	*100	120
10DPGC120/90	268	396	341	3	*120	140
10DPGC130/90	278	406	351	3	*130	150

**Diametri differenti su richiesta** - Custom diameters upon request - Diamètres différents sur demande

**CURVA 45° - 45° ELBOW - COUDE À 45°**

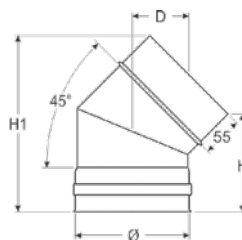
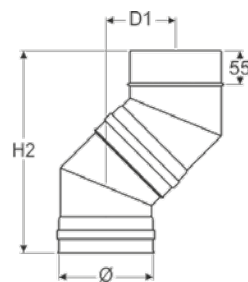

Cod. / Code / Réf.	H	H1	H2	D	D1	N° SET	Ø Int. / Inte. / Intér.	Ø Est. / Exte. / Extér.
10DPGC80/45	128	206	295	69	99	2	*80	100
10DPGC100/45	132	225	319	74	109	2	*100	120
10DPGC120/45	132	238	332	77	115	2	*120	140
10DPGC130/45	151	285	397	90	142	2	*130	150

**Diametri differenti su richiesta** - Custom diameters upon request - Diamètres différents sur demande

**T 90° STACCO MONO - 90° TEE WITH SINGLE WALL CENTRAL FITTING - TÉ À 90° AVEC RACCORD HORIZONTAL SIMPLE PAROI**

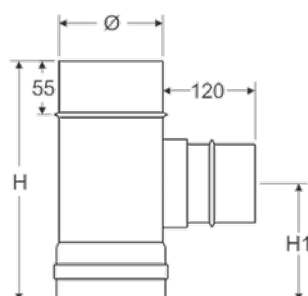

Cod. / Code / Réf.	H	H1	Ø Int. / Inte. / Intér.	Ø Est. / Exte. / Extér.
10DPGT80/90MP	245	120	*80	100
10DPGT100/90MP	255	125	*100	120
10DPGT120/90MP	315	155	*120	140
10DPGT130/90MP	315	155	*130	150

**Diametri differenti su richiesta. Specificare M o F** - Custom diameters upon request. Indicate M or F - Diamètres différents sur demande. Indiquer M ou F

**T 90° STACCO DOPPIA - 90° TEE WITH DOUBLE WALL CENTRAL FITTING - TÉ À 90° AVEC RACCORD HORIZONTAL DOUBLE PAROI**

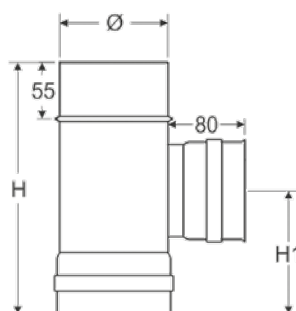

Cod. / Code / Réf.	H	H1	Ø Int. / Inte. / Intér.	Ø Est. / Exte. / Extér.
10DPGT80/90	245	120	*80	100
10DPGT100/90	255	125	*100	120
10DPGT120/90	315	155	*120	140
10DPGT130/90	315	155	*130	150

**Diametri differenti su richiesta** - Custom diameters upon request - Diamètres différents sur demande

**T 90° STACCO RIDOTTO Ø 80 MONO - 90° REDUCING TEE TO Ø 80 SINGLE WALL - TÉ À 90° REDUIT SIMPLE PAROI Ø 80**

Cod. / Code / Réf.	Ø Int. / Inte. /Intér.	Ø Est. / Exte. / Extér.
10DPGTR100-80MP	*100	120
10DPGTR120-80MP	*120	140
10DPGTR130-80MP	*130	150

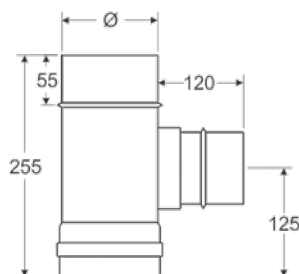

**Diametri differenti su richiesta. Specificare M o F** - Custom diameters upon request. Indicate M or F - Diamètres différents sur demande. Indiquer M ou F

**T 90° STACCO RIDOTTO Ø 80 DOPPIA - 90° REDUCING TEE TO Ø 80 DOUBLE WALL - TÉ À 90° REDUIT DOUBLE PAROI Ø 80**

Cod. / Code / Réf.	Ø Int. / Inte. /Intér.	Ø Est. / Exte. / Extér.
10DPGTR100-80	*100	120
10DPGTR120-80	*120	140
10DPGTR130-80	*130	150

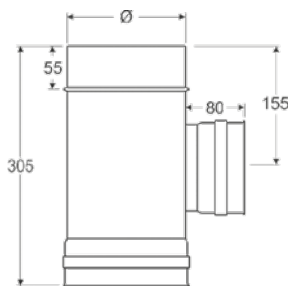

**Diametri differenti su richiesta** - Custom diameters upon request - Diamètres différents sur demande

**MODULO DI ISPEZIONE CONTAPPO TONDO - ELEMENT WITH ROUND INSPECTION DOOR - ÉLÉMENT D'INSPECTION AVEC TRAPPE DE VISITE RONDE**

Cod. / Code / Réf.	H	Øi	Ø Int. / Inte. /Intér.	Ø Est. / Exte. / Extér.
10DPGISP80/90	210	80	*80	100
10DPGISP100/90	245	80	*100	120
10DPGISP120/90	245	80	*120	140
10DPGISP130/90	245	80	*130	150

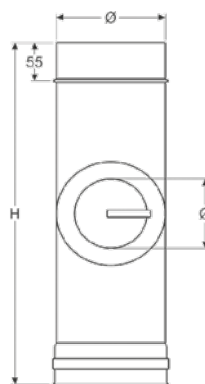

**Diametri differenti su richiesta** - Custom diameters upon request - Diamètres différents sur demande

## SUPPORTO A MURO - WALL SUPPORT - SUPPORT MURAL

Cod. / Code / Réf.	Ø Int. / Inte. /Intér.	Ø Est. / Exté. / Extér.
10DPGSMU80	*80	100
10DPGSMU100	*100	120
10DPGSMU120	*120	140
10DPGSMU130	*130	150

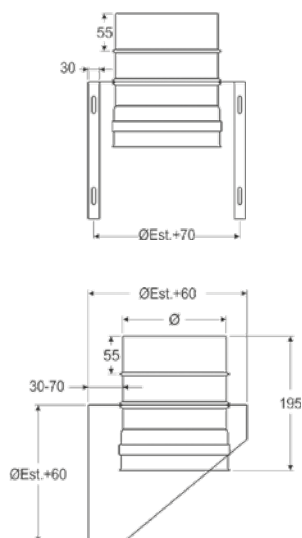

**Diametri differenti su richiesta** - Custom diameters upon request - Diamètres différents sur demande

## ATTRAVERSAMENTO SOLAIO - INTERMEDIATE ANCHOR PLATE - MODULE DE TRAVERSEMENT DE SOL

Cod. / Code / Réf.	Ø Int. / Inte. /Intér.	Ø Est. / Exté. / Extér.
10DPGSOL80	*80	100
10DPGSOL100	*100	120
10DPGSOL120	*120	140
10DPGSOL130	*130	150

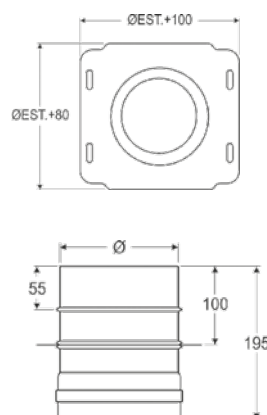

**Diametri differenti su richiesta** - Custom diameters upon request - Diamètres différents sur demande

## RACCORDO MONO-DOPPIA - SINGLE-DOUBLE WALL ADAPTER - RACCORD SIMPLE-DOUBLE PAROI

Cod. Maschio / Male code / Réf. Mâle	Cod. Femmina / Female code / Réf. Femelle	H	Ø Int. / Inte. / Intér.	Ø Est. / Exté. / Extér.
10DPGDM80M	10DPGDM80F	170	*80	100
10DPGDM100M	10DPGDM100F	170	*100	120
10DPGDM120M	10DPGDM120F	170	*120	140
10DPGDM130M	10DPGDM130F	170	*130	150

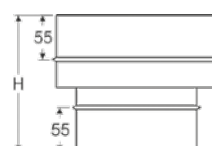
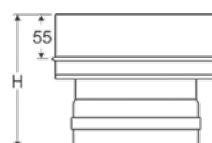

**Diametri differenti su richiesta** - Custom diameters upon request - Diamètres différents sur demande

**RACCORDO DOPPIA-MONO - DOUBLE-SINGLE WALL ADAPTER - RACCORD DOUBLE-SIMPLE PAROI**

Cod. Maschio / Male code / Réf. Mâle	Cod. Femmina / Female code / Réf. Femelle	H	Ø Int. / Inte. / Intér.	Ø Est. / Exte. / Extér.
10DPGMD80M	10DPGMD80F	170	*80	100
10DPGMD100M	10DPGMD100F	170	*100	120
10DPGMD120M	10DPGMD130F	170	*120	140
10DPGMD130M	10DPGMD160F	170	*130	150

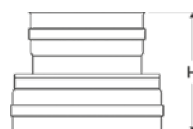
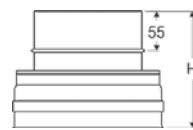

**Diametri differenti su richiesta** - Custom diameters upon request - Diamètres différents sur demande

**RACCOGLI CONDENSA - DRAIN PLUG - BOUCHON DE CONDENSATION**

Cod. / Code / Réf.	Ø Int. / Inte. /Intér.	Ø Est. / Exte. / Extér.
10DPGRC80	*80	100
10DPGRC100	*100	120
10DPGRC120	*120	140
10DPGRC130	*130	150

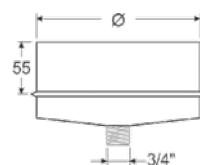

**Diametri differenti su richiesta** - Custom diameters upon request - Diamètres différents sur demande

**COMIGNOLO CINESE - CHINESE CAP - CHAPEAU CHINOIS**

Cod. / Code / Réf.	H	A	He	Ø Int. / Inte. /Intér.	Ø Est. / Exte. / Extér.
10DPGCIN80	205	230	70	80	100
10DPGCIN100	205	265	70	100	120
10DPGCIN120	210	265	75	120	140
10DPGCIN130	225	320	90	130	150

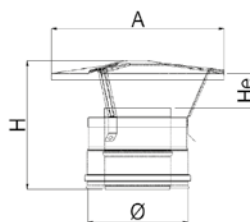

**Diametri differenti su richiesta** - Custom diameters upon request - Diamètres différents sur demande  
**Fascetta non inclusa** - Clamp not included - Collier de jonction pas compris

## COMIGNOLO ANTIVENTO - WINDPROOF CAP - CHAPEAU ANTI-INTEMPÉRIE

Cod. / Code / Réf.	H	A	hF	Ø Int. / Inte. / Intér.	Ø Est. / Exte. / Extér.
10DPGAV80	240	185	165	80	100
10DPGAV100	240	220	165	100	120
10DPGAV120	260	260	200	120	140
10DPGAV130	280	300	200	130	150

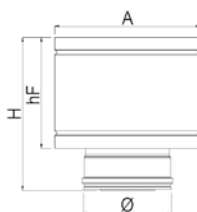

**Diametri differenti su richiesta** - Custom diameters upon request - Diamètres différents sur demande  
**Fascetta non inclusa** - Clamp not included - Collier de jonction pas compris

## COMIGNOLO TORRINO - TOWER CAP - CHAPEAU DONJON

Cod. / Code / Réf.	H	A	hL	N° CONI	Ø Int. / Inte. / Intér.	Ø Est. / Exte. / Extér.
10DPGTOR80	180	130	20	3	80	100
10DPGTOR100	215	150	20	4	100	120
10DPGTOR120	220	180	22	4	120	140
10DPGTOR130	220	180	22	4	130	150

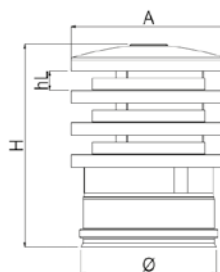

**Diametri differenti su richiesta** - Custom diameters upon request - Diamètres différents sur demande  
**Fascetta non inclusa** - Clamp not included - Collier de jonction pas compris

## COMIGNOLO TRONCO/CONICO - CONE TERMINAL - CÔNE DE FINITION

Cod. / Code / Réf.	Ø Int. / Inte. / Intér.	Ø Est. / Exte. / Extér.
10DPGTC80	80	100
10DPGTC100	100	120
10DPGTC120	120	140
10DPGTC130	130	150

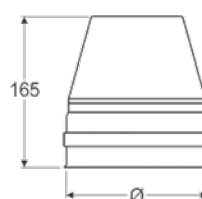

**Diametri differenti su richiesta** - Custom diameters upon request - Diamètres différents sur demande  
**Fascetta non inclusa** - Clamp not included - Collier de jonction pas compris

**TERMINALE ORIZZONTALE DOPPIA PARETE - DOUBLE WALL HORIZONTAL ENDING PART - TERMINAL HORIZONTAL À BEC DOUBLE PAROI**

Cod. / Code / Réf.	L	Ø Int. / Inte. /Intér.	Ø Est. / Exte. / Extér.
10DPGT080	187	80	100
10DPGT0100	202	100	120
10DPGT0120	220	120	140
10DPGT0130	225	130	150

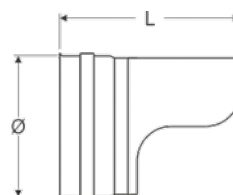

**Diametri differenti su richiesta** - Custom diameters upon request - Diamètres différents sur demande  
**Fascetta non inclusa** - Clamp not included - Collier de jonction pas compris

**STAFFA DI FISSAGGIO A PARETE REGOLABILE DA 50 A 80 mm - ADJUSTABLE WALL BRACKET FROM 50 TO 80 mm - COLLIER DE FIXATION MURAL RÉGLABLE DE 50 À 80 mm**

Cod. / Code / Réf.	Ø	A	B	D
MPS100	100	114	67	50-80
MPS120	120	128	68	50-80
MPS140	140	145	85	50-80
MPS150	150	148	86	50-80

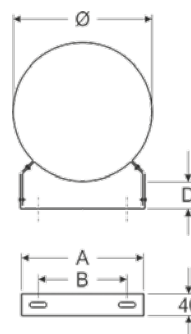

**STAFFA DI FISSAGGIO A PARETE REGOLABILE DA 10 A 150 mm - ADJUSTABLE WALL BRACKET FROM 10 TO 150 mm - COLLIER DE FIXATION MURAL RÉGLABLE DE 10 À 150 mm**

Cod. / Code / Réf.	Ø	A	B
MPSREG100	100	149	94
MPSREG120	120	163	103
MPSREG150	150	200	134
MPSREG180	180	230	170

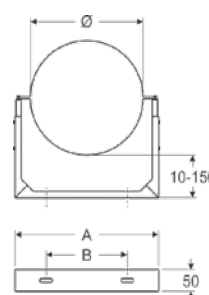

**PROLUNGA PER MPS - MPS EXTENSION - RALLONGE POUR MPS**

Cod. / Code / Réf.	L
PROLMPS105I	105mm
PROLMPS205I	205mm

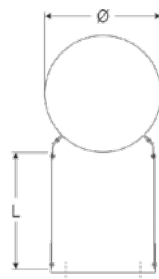

**FALDALE PER TETTI INCLINATI CON BASE IN PIOMBO - FLASHING FOR SLOPED ROOFS WITH LEAD BASE - SOLIN DE TOIT PENTU AVEC BASE EN PLOMB**

Cod. / Code / Réf.	Ø	ØF	A	B	H
MPFI100	100	130	500	700	180
MPFI120	120	160	500	700	180
MPFI140	150	180	500	700	180
MPFI150	180	180	500	700	180

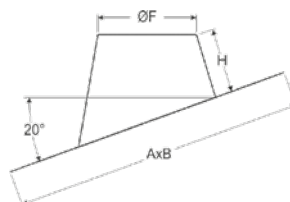

**FALDALE PER TETTI PIANI - FLASHING FOR FLAT ROOFS - SOLIN TOITS TERRASSE**

Cod. / Code / Réf.	Ø	A	B
MPFP100	100	300	300
MPFP120	120	310	310
MPFP140	140	330	330
MPFP150	150	330	330

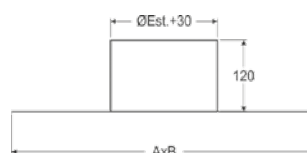

DP INOX +  
DP INOX SP10



# GREMBIULINA DITENUTA - STORM COLLAR - COLLET ANTI-INTEMPÉRIE

Cod. / Code / Réf.	Ø
MPGRE100	100
MPGRE120	120
MPGRE140	140
MPGRE150	150

